



Les Toons Kaboom Technical Rider

2024 / 2025

Requirements

Stage

- Playing area of at least 8m wide x 6m deep
- Black Marley / dancefloor on the whole surface (a dancefloor can be brought by us, please contact us in advance!)
- Black curtains with at least 2, preferably 3 or more wings per side
- The stage must be cleaned before rehearsals and every show.

Light (check light plot)

- At least 6x 1kW profiles, pc's or Fresnel as front light
- 11x profile lamps, ideally LED with nice colors (ETC lustr+ / colorsource preferred)
- 4x professional LED wash moving heads (if necessary, we can rent and bring them)
- 10x LED-Pars with zoom, in 2 rows of 5, as backlights.
- 1-2x good quality hazers, MDG-Atmosphere preferred.
- GrandMA2 lighting desk, a command wing + laptop can be brought by us.
- house lights dimmable from FoH or via DMX
- Light and sound desk are operated by one person and must be setup next to each other!
- Everything set up and ready to play at our arrival.

Sound

- Present-day, professional P.A. including subs and possibly delays
- 2x professional monitors on stage, upstage left and right / floor or hanging
- Present-day, professional sound mixing console with fully parametric EQs for all input and output channels. (Yamaha QL/CL/Rivage preferred)
- Light and sound desk are operated by one person and must be setup next to each other!
- 1x handheld wireless mic (SM58 or comparable) including receiver and batteries
- 2x DI's and XLR-inputs for the looper (on stage)
- One power socket for the looper
- Everything set up and ready to play from 1 pm on the show day



Personnel / Parking

- At least 1 competent technician for setup, lighting, sound check and during the show.
- 2x parking spaces nearby.

Schedule for the show at 8 pm (may vary slightly depending on the tour)

- 1:00 pm: Get-in technician for setup, light focus etc.
- 3:00 pm: Get-in artists, soundcheck, technical run
- 6:00 pm: Dinner for everyone (Dinner must be on the table by 6pm latest!)
- 7:30 pm: Earliest hall opening (please advise if earlier!)
- 8:00 pm: show, 70 mins without intermission

Goodbye!

Thank you for implementing these requirements – we're looking forwards to the show and your hospitable house. If these requirements cannot be met, please contact us early enough. we can simplify the setup and adapt the show to your venue. But we need enough time to get this planned properly. Also, we're willing to find a good solution for many things, but we do not like negative surprises on site.

Contact for technical questions





Allez! Jay Schuetz
jay@allez-gmbh.ch
+41 79 573 19 91 (email preferred!)

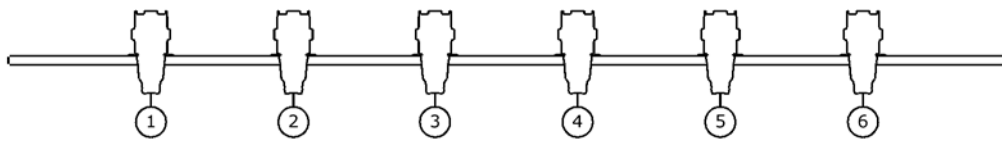
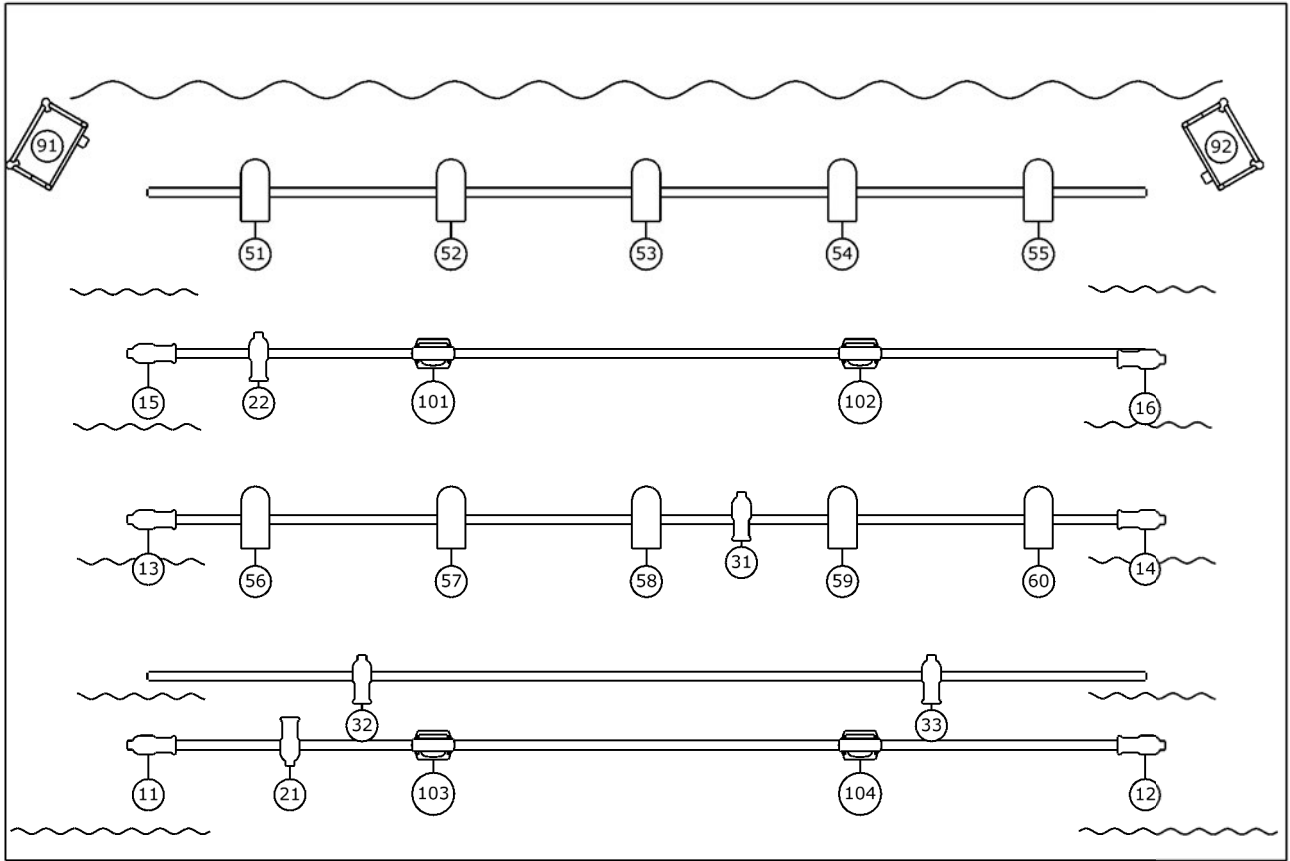

Les Toons - Kaboom!
2024 - Light plot version 1.0



Symbol Key

-  profile lamp, ideally LED RGBW (11)
-  LED-Par with motorised zoom (10)
-  Front-Lights: profiles, PC's or fresnels (6)
-  mid-sized wash moving-head, i.e. Robe Robin 300+, Mini-B, Mac Aura.. (4)
-  1 - 2 good Hazers, MDG Atmosphere preferred!

Allez!

Contact:
Allez! GmbH
Jay Schuetz
+41 79 573 19 91
jay@allez-gmbh.ch (mail preferred)